

FITTINGS FOR SOCKET WELDING

Fittings, metric series ISO-UNI



FITTINGS FOR SOCKET WELDING

Series of fittings designed for conveying fluids under pressure with a hot weld connection system (socket welding).

FITTINGS, METRIC SERIES ISO-UNI

Technical specifications	
Size range	d 20 ÷ d 110 (mm)
Nominal pressure	PN 10 with water at 20° C
Temperature range	0 °C ÷ 95 °C
Coupling standards	Welding: EN ISO 15494. Can be coupled to pipes according to EN ISO 15494 Flanging system: ISO 7005-1, EN 1092-1, EN ISO 15494, ANSI B16.5 cl.150
Reference standards	Construction criteria: EN ISO 15494 Test methods and requirements: EN ISO 15494 Installation criteria: DVS 2202-1, DVS 2207-11, DVS 2208-1, UNI 11318
Fitting material	PP-H
Seal material	EPDM, FKM

TECHNICAL DATA

PRESSURE VARIATION ACCORDING TO TEMPERATURE

Graph valid for water and non-hazardous fluids with regard to which the material is classified as CHEMICALLY RESISTANT. In other cases, a reduction of the nominal pressure PN is required.

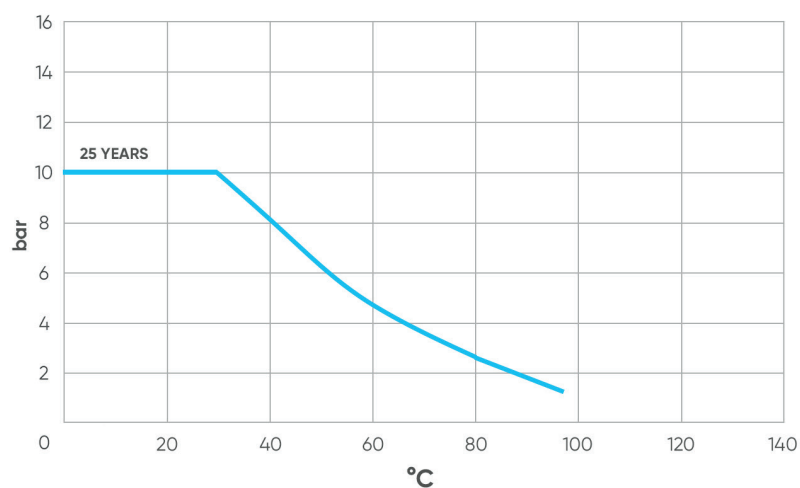

DIMENSIONS

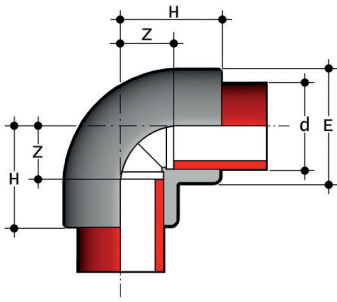

GIM

90° elbow for socket welding

d	E	H	Z	g	Code
20	28	28	13	14	GIM020
25	34	32	16	23	GIM025
32	42	37	20	37	GIM032
40	52	43	22	64	GIM040
50	64	51	28	105	GIM050
63	79	61	34	180	GIM063
75	93	73	42	300	GIM075
90	111	85	49	455	GIM090
110	135	101	59	815	GIM110

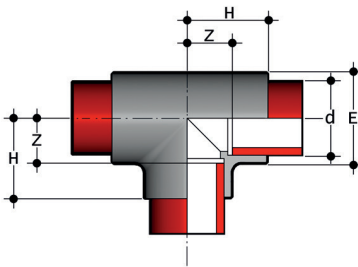

TIM

90° Tee for socket welding

d	E	H	Z	g	Code
20	28	28	13	19	TIM020
25	34	32	16	30	TIM025
32	42	37	19	47	TIM032
40	52	43	23	80	TIM040
50	64	52	29	145	TIM050
63	80	63	35	250	TIM063
75	93	71	40	370	TIM075
90	111	82	46	560	TIM090
110	135	100	58	990	TIM110

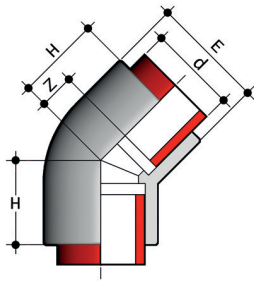

HIM

45° elbow for socket welding

d	E	H	Z	g	Code
20	28	21	7	12	HIM020
25	34	25	9	19	HIM025
32	42	29	12	33	HIM032
40	52	36	15	57	HIM040
50	63	43	19	105	HIM050
63	79	51	24	182	HIM063
75	92	53	20	200	HIM075
90	113	61	23,5	335	HIM090
110	135	71	28	610	HIM110

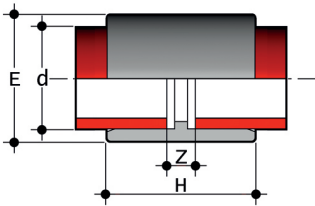

MIM

Double socket for socket welding

d	E	H	Z	g	Code
20	28	36	8	10	MIM020
25	34	39	8	16	MIM025
32	42	43	9	25	MIM032
40	52	47	8	39	MIM040
50	63	55	8	62	MIM050
63	78	61	9	96	MIM063
75	91	70	10	145	MIM075
90	109	80	10	230	MIM090
110	132	93	12	370	MIM110

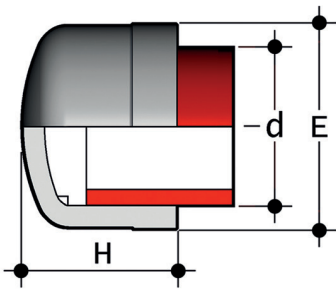

CIM

End cap for socket welding

d	E	H	g	Code
20	28	25	7	CIM020
25	34	27	11	CIM025
32	42	32	19	CIM032
40	51	36	31	CIM040
50	63	41	50	CIM050
63	78	44	88	CIM063
75	91	48	116	CIM075
90	109	65	212	CIM090
110	132	71	349	CIM110

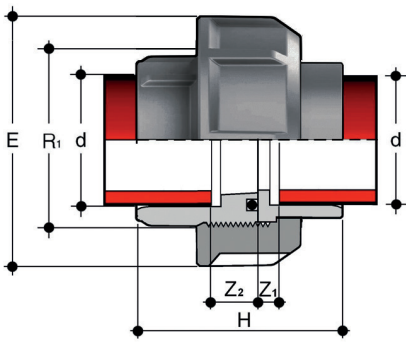

BIGM

Union for socket welding with O-Ring in EPDM or FKM

d	R ₁	PN	E	H	Z ₁	Z ₂	g	EPDM code	FKM code
20	1"	10	47	45,5	12	5,5	34	BIGM020E	BIGM020F
25	1 1/4"	10	58	49,5	12	5,5	59	BIGM025E	BIGM025F
32	1 1/2"	10	65	53,5	12	5,5	73	BIGM032E	BIGM032F
40	2"	10	78	59,5	14	5,5	115	BIGM040E	BIGM040F
50	2 1/4"	10	85	67,5	16	5,5	146	BIGM050E	BIGM050F
63	2 3/4"	10	103	79,5	20	5,5	249	BIGM063E	BIGM063F

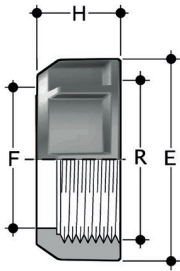

EFGM

Union nut with BSP thread for union types BIGM, BIFGM, BIFOM, BIROM, BIFXM, BIRXM

R	d BIGM	PN	E	F	H	g	Code
1"	20	10	47	28	22	19	EFGM100
1 1/4"	25	10	58	36	25	29	EFGM114
1 1/2"	32	10	65	42	27	40	EFGM112
2"	40	10	78	53	30	57	EFGM200
2 1/4"	50	10	85	59	33	74	EFGM214
2 3/4"	63	10	103	74	38	119	EFGM234

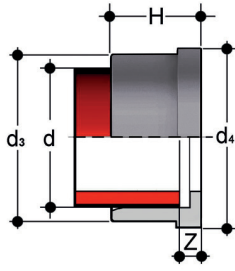

Q/BIGM

Union end for socket welding, metric series

d	PN	d ₃	d ₄	H	Z	g	Code
20	10	27,5	30,1	19,5	5,5	7	QBIGM020
25	10	36	38,8	21,5	5,5	14	QBIGM025
32	10	41,5	44,7	23,5	5,5	17	QBIGM032
40	10	53	56,5	25,5	5,5	30	QBIGM040
50	10	59	62,6	28,5	5,5	30	QBIGM050
63	10	74	78,4	32,5	5,5	51	QBIGM063

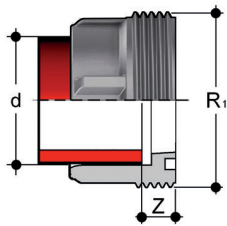

F/BIGM

Union bush for socket welding, metric series

d	R ₁	PN	Z	g	Code
20	1"	10	12	10	FBIGM020
25	1 1/4"	10	12	17	FBIGM025
32	1 1/2"	10	12	24	FBIGM032
40	2"	10	14	39	FBIGM040
50	2 1/4"	10	16	47	FBIGM050
63	2 3/4"	10	18	89	FBIGM063

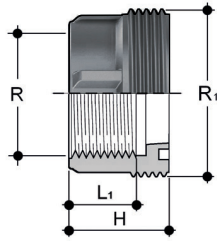

F/BFGM

Union bush for socket welding, metric series

d	R ₁	PN	Z	g	Code
20	1"	10	12	10	FBIGM020
25	1 ¹ / ₄ "	10	12	17	FBIGM025
32	1 ¹ / ₂ "	10	12	24	FBIGM032
40	2"	10	14	39	FBIGM040
50	2 ¹ / ₄ "	10	16	47	FBIGM050
63	2 ³ / ₄ "	10	18	89	FBIGM063

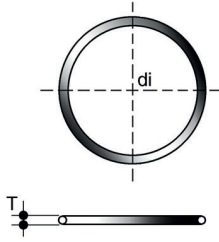

O-RING

Seals for union types BIGM, BIFGM, BIFOM, BIROM, BIFXM, BIRXM

d union	C	di	T	Code	Code
16	3062	15,54	2,62	OR3062E	OR3062F
20	4081	20,22	3,53	OR4081E	OR4081F
25	4112	28,17	3,53	OR4112E	OR4112F
32	4131	32,93	3,53	OR4131E	OR4131F
40	6162	40,65	5,34	OR6162E	OR6162F
50	6187	47	5,34	OR6187E	OR6187F
63	6237	59,69	5,34	OR6237E	OR6237F
75	6300	75,57	5,34	OR6300E	OR6300F
90	6362	91,45	5,34	OR6362E	OR6362F
110	6450	113,67	5,34	OR6450E	OR6450F

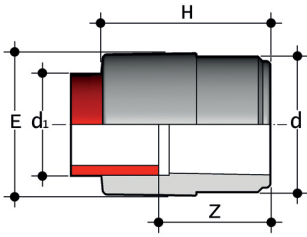

RIM

Reducer: spigot (d), reduced socket for socket welding (d₁)

d x d ₁	E	H	Z	g	Code
25 x 20	28	39	25	10	RIM025020
32 x 20	36	43	30	13	RIM032020
32 x 25	34	46	30	17	RIM032025
40 x 25	42	48	33	24	RIM040025
40 x 32	42	51	33	27	RIM040032
50 x 32	52	54	36	39	RIM050032
50 x 40	52	57	36	44	RIM050040
63 x 32	65	61	44	69	RIM063032
63 x 50	65	68	44	76	RIM063050
75 x 50	78	69	47	106	RIM075050
75 x 63	78	75	47	115	RIM075063
90 x 63	92	82	56	156	RIM090063
90 x 75	92	88	56	175	RIM090075
110 x 63	112	93	66	290	RIM110063
110 x 90	112	102	66	305	RIM110090

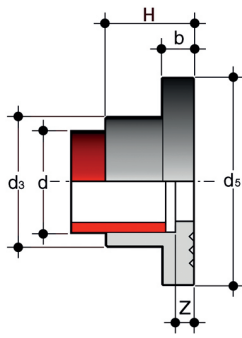

QRNM

Stub with serrated face (according to DIN standards) for socket welding, for use with backing rings ODB

d	DN	b	d ₃	d ₅	H	Z	g	Code
20	15	7	27	45	20	6	12	QRNM020
25	20	9	33	58	22	6	24	QRNM025
32	25	10	41	68	25	6	36	QRNM032
40	32	11	50	78	27	6	47	QRNM040
50	40	12	61	88	30	6	63	QRNM050
63	50	14	76	102	34	6	94	QRNM063
75	65	16	90	122	38	6	149	QRNM075
90	80	17	108	138	44	8	213	QRNM090
*110	100	18	131	158	50	8	297	QRNM110

*ODB125 to be used

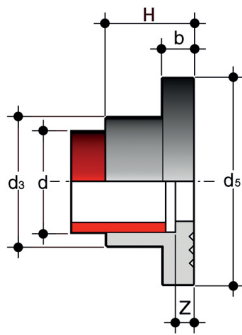

GRAM

Stub with serrated face for socket welding, for used with backing rings OAB (for other dimensions use QRNM)

d	DN	OAB size	b	d ₃	d ₅	H	Z	g	Code
25	20	3/4"	9	33	22	6	24	24	GRAM034
32	25	1"	10	41	25	6	36	36	GRAM100
40	32	1 1/4"	11	50	27	6	47	47	GRAM114
50	40	1 1/2"	12	61	30	6	63	63	GRAM112
90	80	3"	17	108	44	8	213	213	GRAM300

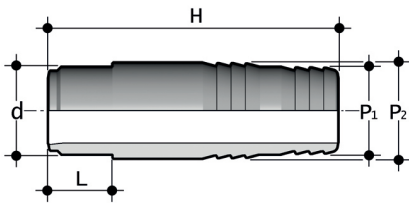

AIM

Hose adaptor with male end for socket welding

$d \times P_2 \times P_1$	H	L	g	DN	Code
20 x 22 x 20	67	16	11	15	AIM020022020
25 x 27 x 25	81	18	20	20	AIM025027025
32 x 32 x 30	95	20	33	25	AIM032032030
40 x 42 x 40	104	22	68	32	AIM040042040
50 x 52 x 50	111	25	100	40	AIM050052050
63 x 64 x 60	122	29	150	50	AIM063064060

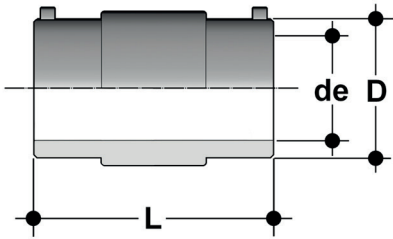

MIMEF

Socket coupling for electrofusion SDR 11 and 17,6

de	D	L	g	Code
*20	30	69	42	MIMEF1117020
*25	35	77	50	MIMEF1117025
*32	44	79	73	MIMEF1117032
40*	53	92	96	MIMEF1117040
*50	64	102	131	MIMEF1117050
*63	80	117	227	MIMEF1117063
*75	95	128	333	MIMEF1117075
*90	112	144	486	MIMEF1117090
*110	136	159	813	MIMEF1117110
*125	153	170	1089	MIMEF1117125
*140	170	183	1365	MIMEF1117140
*160	194	185	1651	MIMEF1117160
*180	218	210	2800	MIMEF1117180
*200	250	210	3700	MIMEF1117200
*225	273	210	3900	MIMEF1117225
*250	315	250	7200	MIMEF1117250
*280	355	290	10800	MIMEF1117280
*315	376	290	9600	MIMEF1117315

*made in PPR
All resale products

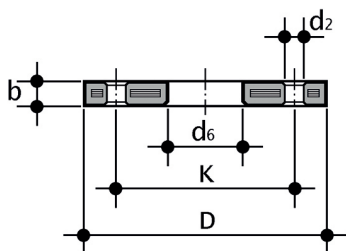

ODB

Steel core backing ring, PP/FRP coated, according to EN/ISO/DIN for stub QRNM. Drilling: PN 10/16

d	DN	*PMA (bar)	b	D	d ₂	d ₆	K	M	n	**Nm	g	Code
20	15	16	12	14	28	95	65	M12	4	15	232	ODB020
25	20	16	14	14	34	105	75	M12	4	15	288	ODB025
32	25	16	14	14	42	115	85	M12	4	15	544	ODB032
40	32	16	16	18	51	140	100	M16	4	20	836	ODB040
50	40	16	16	18	62	150	110	M16	4	30	902	ODB050
63	50	16	19	18	78	165	125	M16	4	35	1074	ODB063
75	65	16	19	18	92	185	145	M16	4	40	1368	ODB075
90	80	16	21	18	108	200	160	M16	8	40	1516	ODB090
***125	100	16	22	18	135	220	180	M16	8	40	1938	ODB125

*PMA maximum admissible working pressure

**nominal tightening torque

***d125: for stubs QRNM d 110

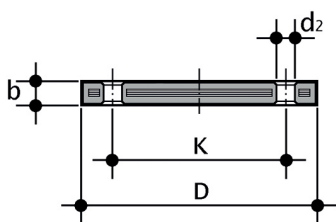

ODBC

Steel core blind flange, PP/FRP according to EN/ISO/DIN. Drilling: PN 10/16

d	DN	*PMA (bar)	b	d ₂	D	k	M	n	**Nm	g	Code
20	15	10	16	14	95	65	M12	4	15	290	ODBC020
25	20	10	12	18	105	75	M12	4	15	380	ODBC025
32	25	10	18	14	115	85	M12	4	15	600	ODBC032
40	32	10	17	18	140	100	M16	4	25	830	ODBC040
50	40	10	18	18	150	110	M16	4	35	1105	ODBC050
63	50	10	18	18	165	125	M16	4	35	1308	ODBC063
75	65	10	18	18	185	145	M16	4	40	1580	ODBC075
90	80	10	20	18	200	160	M16	8	40	2244	ODBC090
110	100	10	20	18	220	180	M16	8	45	2829	ODBC110

*PMA maximum admissible working pressure

**nominal tightening torque

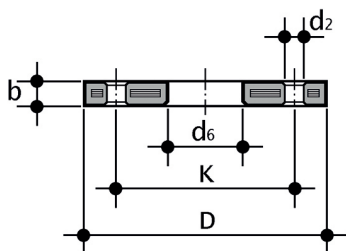

OAB

Steel core backing ring, PP/FRP coated according to ANSI B16.5 cl.150 for stubs QRNM and GRAM

d (inch)	DN	*PMA (bar)	b	d ₂ (mm)	d ₂ (inch)	d ₆	D	k(mm)	k(inch)	n	**Nm	g	Code
1/2"	15	16	12	16	5/8"	28	95	60,45	2" 3/8	4	15	200	OAB012
3/4"	20	16	12	16	5/8"	34	102	69,85	2" 3/4	4	15	240	OAB034
1"	25	16	16	16	5/8"	42	114	79,25	3" 1/8	4	15	490	OAB100
1" 1/4	32	16	16	16	5/8"	51	130	88,9	3" 1/2	4	25	670	OAB114
1" 1/2	40	16	18	16	5/8"	62	133	98,55	3" 7/8	4	35	640	OAB112
2"	50	16	18	20	3/4"	78	162	120,65	4" 3/4	4	35	1000	OAB200
2" 1/2	65	16	18	20	3/4"	92	184	139,7	5" 1/2	4	40	1310	OAB212
3"	80	16	18	20	3/4"	111	194	152,4	6"	4	40	1250	OAB300
4"	100	16	18	20	3/4"	133	229	190,5	7" 1/2	8	40	1660	OAB400

*PMA maximum admissible working pressure
**nominal tightening torque

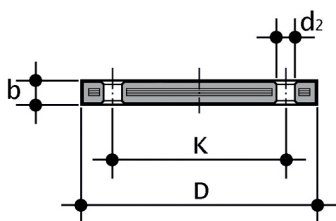

OABC

Steel core blind flange, PP/FRP coated according to ANSI B16.5 cl.150

d (inch)	DN	*PMA (bar)	B	D	d ₂ (mm)	d ₂ (inch)	K (mm)	k(inch)	**Nm	n	g	Code
1/2"	15	16	12	95	16	5/8"	60,45	2"3/8	15	4	200	OABC012
3/4"	20	16	12	102	16	5/8"	69,85	2"3/4	15	4	240	OABC034
1"	25	16	16	114	16	5/8"	79,25	3"1/8	15	4	370	OABC100
1" 1/4	32	16	16	130	16	5/8"	88,90	3"1/2	25	4	530	OABC114
1" 1/2	40	16	18	133	16	5/8"	98,55	3"7/8	35	4	560	OABC112
2"	50	16	18	162	20	3/4"	120,65	4"3/4	35	4	810	OABC200
2" 1/2	65	16	18	184	20	3/4"	139,70	5"1/2	40	4	1070	OABC212
3"	80	16	18	194	20	3/4"	152,40	6"	40	4	1030	OABC300
4"	100	16	18	229	20	3/4"	190,50	7"1/2	40	8	1570	OABC400

*PMA maximum admissible working pressure
**nominal tightening torque

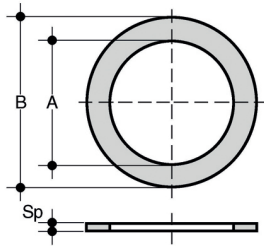

QHV/X

Flat gasket in EPDM and FKM for flanges according to EN 1092

d	DN	A	B	Sp	EPDM code	FKM code
20 - 1/2"	15	20	32	2	QHVX020E	QHVX020F
25 - 3/4"	20	24	38,5	2	QHVX025E	QHVX025F
32 - 1"	25	32	48	2	QHVX032E	QHVX032F
40 - 1" 1/4	32	40	59	2	QHVX040E	QHVX040F
50 - 1" 1/2	40	50	71	2	QHVX050E	QHVX050F
63 - 2"	50	63	88	2	QHVX063E	QHVX063F
75 - 2" 1/2	65	75	104	2	QHVX075E	QHVX075F
90 - 3"	80	90	123	2	QHVX090E	QHVX090F
110 - 4"	100	110	148	3	QHVX110E	QHVX110F

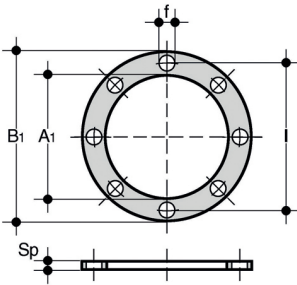

QHV/Y

Flat gasket in EPDM for flanges according to EN 1092, self-centring for flanges drilled PN 10/16

d	DN	A	B ₁	F	l	U	Sp	Code
20 - 1/2"	15	17	95	14	65	4	2	QHVY020E
25 - 3/4"	20	22	107	14	76,3	4	2	QHVY025E
32 - 1"	25	28	117	14	86,5	4	2	QHVY032E
40 - 1" 1/4	32	36	142,5	18	101	4	2	QHVY040E
50 - 1" 1/2	40	45	153,3	18	111	4	2	QHVY050E
63 - 2"	50	57	168	18	125,5	4	2	QHVY063E
75 - 2" 1/2	65	71	187,5	18	145,5	4	3	QHVY075E
90 - 3"	80	84	203	18	160	8	3	QHVY090E
110 - 4"	100	102	223	18	181	8	3	QHVY110E