

BS FITTINGS



FITTINGS ACCORDING TO BRITISH
STANDARD



BS FITTINGS

Series of fittings for pipes conveying fluids under pressure with solvent weld and threaded joints according to British Standard.

FITTINGS ACCORDING TO BRITISH STANDARD

Technical specifications	
Size range	d 1/2" ÷ 8"
Nominal pressure	up to 15 bar with water at 20 °C
Temperature range	0 °C ÷ 60 °C
Coupling standards	<p>Solvent welding: BS 4346-1, ASTM D 2467, JIS K 6743, ISO 727, EN ISO 15493, , EN ISO 1452 Can be coupled to pipes according to ISO 7, ASTM D 2464, JIS B 0203</p> <p>Thread: ISO 7, EN 10226-1/2, EN ISO 1452, EN ISO 15493, DIN 8062, ASTM D 1785, JIS K674</p> <p>Flanging system: BS 10 Tab. E</p>
Reference standards	<p>Construction criteria: ISO 7, ASTM D 2464, JIS B 0203, EN ISO 1452, EN ISO 15493</p> <p>Test methods and requirements: BS 4346-1</p> <p>Installation criteria: DVS 2204, DVS 2221, UNI 11242</p>
Fittings material	PVC-U dark grey RAL 7011
Seal material	EPDM

TECHNICAL DATA

PRESSURE VARIATION ACCORDING TO TEMPERATURE

For water and non-hazardous fluids with regard to which the material is classified as CHEMICALLY RESISTANT. In other cases, a reduction of the nominal pressure PN is required (25 years with safety factor).

class E 15 bar
class D 12 bar
class C 9 bar

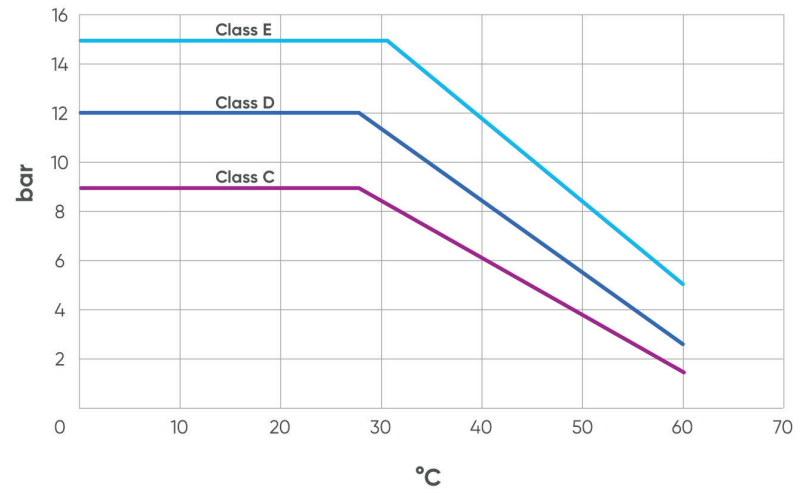

DIMENSIONS

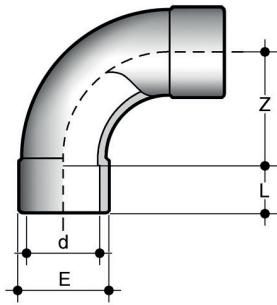

SLV

90° long radius bend (R=2D) with solvent weld sockets

d	PN	E	L	Z	g	Class	Code
2"1/2	15	94	44	150	1000	E	SIV075

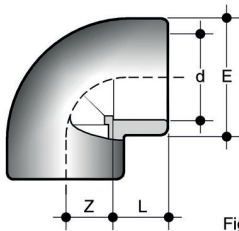
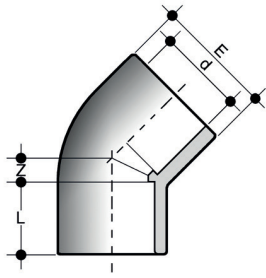

Fig. A

GLV

90° elbow with solvent weld sockets

d	PN	E	L	Z	g	Class	Code
1/2"	15	27	16,5	10,5	15	E	GLV012
3/4"	15	33	19,5	13,5	30	E	GLV034
1"	15	41	22,5	17	45	E	GLV100
1"1/4	15	54	27	21,5	110	D	GLV114
1"1/2	15	61	31	27	160	E	GLV112
2"	15	76	38	33,5	340	E	GLV200
2"1/2	15	90	44	40,5	427	E	GIV075
3"	15	108	51	48	768	E	GLV300
4"	15	131	63	58	972	E	GLV400
6"	12	186	86	82	2920	D	GLV600
8"	12	257	115,5	169,5	8850	D	GLV800



HLV

45° elbow with solvent weld sockets

d	PN	E	L	Z	g	Class	Code
1/2"	15	27	16,5	5	13	E	HLV012
3/4"	15	33	19,5	5,5	20	E	HLV034
1"	15	41	22,5	7	45	E	HLV100
1"1/4	15	50	26	10,5	85	D	HLV114
1"1/2	15	61	31	11,5	155	E	HLV112
2"	15	76	38	14	291	E	HLV200
2"1/2	15	90	44	17	315	E	HIV075
3"	15	107,5	51	21,5	565	E	HLV300
4"	15	131	61	26	740	E	HLV400

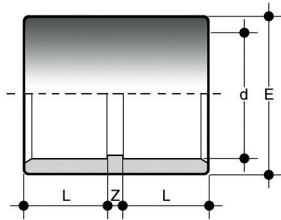

MLV

Solvent weld double socket

d	PN	E	L	Z	g	Class	Code
1/2"	15	27	16,5	2	13	E	MLV012
3/4"	15	33	19,5	2	15	E	MLV034
1"	15	41	22,5	2	36	E	MLV100
1"1/4	15	50	26	3	58	D	MLV114
1"1/2	15	61	31	3	118	E	MLV112
2"	15	76	38	3	206	E	MLV200
2"1/2	15	90	44	4	250	E	MIV075
3"	15	108	50,5	5,5	420	E	MLV300
4"	15	131	63	5	680	E	MLV400
6"	12	194,5	90	10	1800	D	MLV600
8"	12	257	115,5	12	4950	D	MLV800

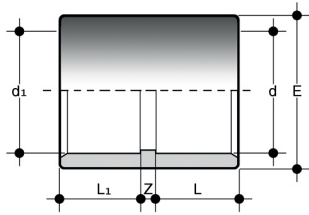

MILV

mm/inch double socket union, one socket for solvent welding to metric pipes and one for solvent welding to imperial (inches) pipes

d x d ₁	PN	E	L	L ₁	Z	g	Class	Code
20 x 1/2"	15	27	16	16,5	2,5	12	E	MILV020012
25 x 3/4"	15	33	19	19,5	2,5	22	E	MILV025034
32 x 1"	15	41	22	22,5	2,5	44	E	MILV032100
40 x 1 1/4"	15	50	26	27	2,0	65	E	MILV040114
50 x 1 1/2"	15	61	31	30	4,0	125	E	MILV050112
63 x 2"	15	76	38	36	5,0	210	E	MILV063200
75 x 2 1/2"	15	90	44	44	4,0	250	E	MIV075
90 x 3"	15	108	51	50,5	5,5	438	E	MILV090300
110 x 4"	15	131	61	63	4,0	852	E	MILV110400

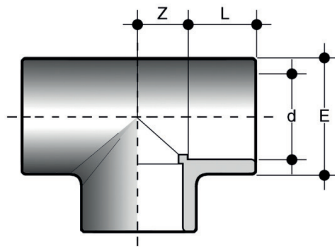

TLV

90° Tee with solvent weld sockets

d	PN	E	L	Z	g	Class	Code
1/2"	15	27	16,5	10,5	26	E	TLV012
3/4"	15	33	19,5	13,5	30	E	TLV034
1"	15	41	22,5	17	55	E	TLV100
1 1/4"	15	50	26	22	90	D	TLV114
1 1/2"	15	61	31	27	257	E	TLV112
2"	15	76	38	33,5	495	E	TLV200
2 1/2"	15	90	44	40,5	560	E	TIV075
3"	15	108	51	48	970	E	TLV300
4"	15	131	63	59	1260	E	TLV400
6"	12	186	86	82	3855	D	TLV600
8"	12	257	115,5	116	10500	D	TLV800

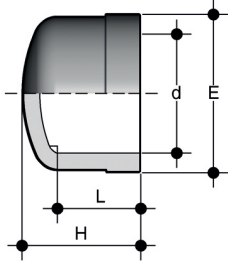

CLV

End cap with solvent weld socket

d	PN	E	L	Z	g	Class	Code
1/2"	15	28	16	4	49	E	CLV012
3/4"	15	33	19,5	2	15	E	CLV034
1"	15	41	22,5	2	36	E	CLV100
1"1/4	15	50	26	3	58	E	CLV114
1"1/2	15	61	31	3	118	E	CLV112
2"	15	76	38	3	206	E	CLV200
2"1/2	15	90	44	4	250	E	CIV075
3"	15	108	50,5	5,5	420	E	CLV300
4"	15	131	63	5	680	E	CLV400

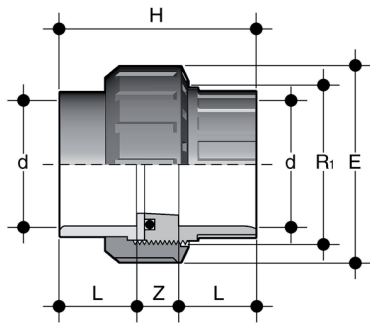

BLV

Union with solvent weld sockets, O-Ring in EPDM

d	PN	R ₁	E	H	L	Z	g	Class	Code
1/2"	15	1"	40.5	45	16	13	39	E	BLV012E
3/4"	15	1 1/4"	50	51	19	13	65	E	BLV034E
1"	15	1 1/2"	57.5	57	22	13	94	E	BLV100E
1 1/4"	15	2"	71.5	67	26	15	150	E	BLV114E
1 1/2"	15	2 1/4"	79	79	31	17	190	E	BLV112E
2"	15	2 3/4"	98	98	38	21	400	E	BLV200E

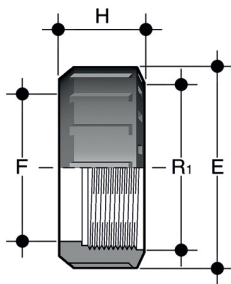

EFV

Union nut with BSP thread for union types BIV, BIFV, BFV, BLV, BIRV, BIFOV, BIROV, BIFXV, BIRXV

R	d BLV	PN	E	F	H	g	Code
1/2"	-	16	27	17	24	8	EFV012
3/4"	16	16	33	22	21	9	EFV034
1"	20	16	41	28	22	13	EFV100
1 1/4"	25	16	50	36	25	22	EFV114
1 1/2"	32	16	58	42	27	30	EFV112
2"	40	16	72	53	30	50	EFV200
2 1/4"	50	16	79	59	34	68	EFV214
2 1/2"	-	16	90	68	36	95	EFV212
2 3/4"	63	16	98	74	38	120	EFV234
3 1/2"	75	10	120	93	45	198	EFV312
4"	90	10	135	106	52	278	EFV400
5"	110	10	163	129	60	448	EFV500

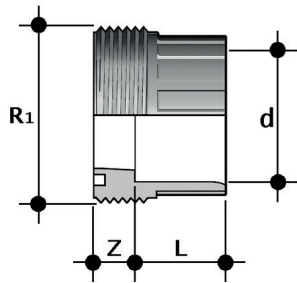

F/BLV

Union bush for solvent welding, series BS for union types BIV, BIFV, BFV, BLV, BIRV, BIFOV, BIROV, BIFXV, BIRXV

d	R ₁	PN	L	Z	g	Code
1/2"	1"	15	16	10	12,5	FBLV012
3/4"	1 1/4"	15	19	10	22,5	FBLV034
1"	1 1/2"	15	22	10	30	FBLV100
1 1/4"	2"	15	26	12	52	FBLV114
1 1/2"	2 1/2"	15	31	14	69,5	FBLV112
2"	2 3/4"	15	38	19	133,5	FBLV200

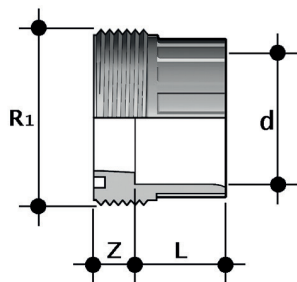

F/BIV

Union bush for solvent welding, metric series for union types BIV, BIFV, BFV, BLV, BIRV, BIFOV, BIROV, BIFXV, BIRXV

d	R ₁	PN	L	Z	g	Code
16	3/4"	16	14	10	9	FBIV016
20	1"	16	16	10	13	FBIV020
25	1 1/4"	16	19	10	25	FBIV025
32	1 1/2"	16	22	10	31	FBIV032
40	2"	16	26	12	58	FBIV040
50	2 1/4"	16	31	14	63	FBIV050
63	2 3/4"	16	38	19	119	FBIV063
75	3 1/2"	10	44	18	230	FBIV075
90	4"	10	51	18	290	FBIV090
110	5"	10	61	18	500	FBIV110

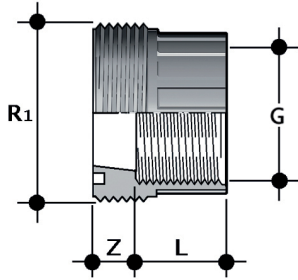

F/BFV

Union bush with BSP threaded female end for union types BIV, BIFV, BFV, BLV, BIRV, BIFOV, BIOV, BIFXV, BIRXV

G	R ₁	PN	L ₁	Z	g	Code
3/8"	3/4"	16	11,4	12,6	8	FBFV038
1/2"	1"	16	15	11	13	FBFV012
3/4"	1 1/4"	16	16,3	12,7	22	FBFV034
1"	1 1/2"	16	19,1	12,9	32	FBFV100
1 1/4"	2"	16	21,4	16,6	57	FBFV114
1 1/2"	2 1/4"	16	21,4	16,5	64	FBFV112
2"	2 3/4"	16	25,7	20,5	122	FBFV200

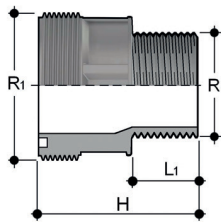

F/BRV

Union bush with BSP threaded male end for union types BIV, BIFV, BFV, BLV, BIRV, BIFOV, BIOV, BIFXV, BIRXV

R	R ₁	PN	L ₁	g	Code
1 1/2"	2 1/4"	16	22,5	100	FBRV112214
2"	2 1/4"	16	27	120	FBRV200214
2"	2 3/4"	16	27	175	FBRV200234

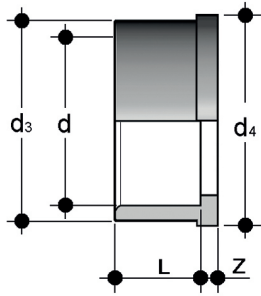

Q/BLV

Union end for solvent welding, BS series for union types BIV, BIFV, BFV, BLV, BIRV, BIFOV, BIROV, BIFXV, BIRXV

d	PN	d ₃	d ₄	L	Z	g	Code
1/2"	15	27,5	30,1	16	3	8	QBLV012
3/4"	15	36	38,8	19	3	13	QBLV034
1"	15	41,5	44,7	22	3	19	QBLV100
1 1/4"	15	53	56,5	26	3	32	QBLV114
1 1/2"	15	59	62,6	31	3	46	QBLV112
2"	15	74	78,4	38	3	86	QBLV200

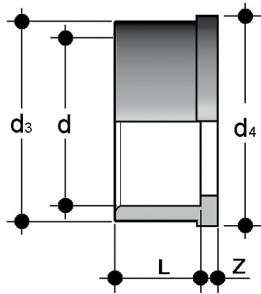

Q/BAV

Union end for solvent welding, ASTM series for union types BIV, BIFV, BFV, BLV, BIRV, BIFOV, BIROV, BIFXV, BIRXV

d	PN	d ₃	d ₄	L	Z	g	Code
1/2"	16	27,5	30,1	22,7	3,5	15,5	QBAV012
3/4"	16	36	38,8	25,9	3,7	22,5	QBAV034
1"	16	41,5	44,7	29,2	3	32,5	QBAV100
1 1/4"	16	53	56,5	32	5	57	QBAV114
1 1/2"	16	59	62,6	35	5	78	QBAV112
2"	16	74	78,4	38,5	5,5	130	QBAV200

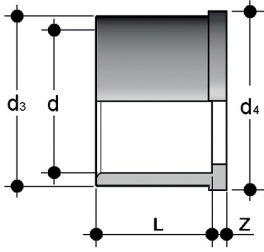

Q/BJV

Union end for solvent welding, JIS series for union types BIV, BIFV, BFV, BLV, BIRV, BIFOV, BIROV, BIFXV, BIRXV

d	PN	d ₃	d ₄	L	Z	g	Code
1/2"	16	27,5	30,1	30	3	16	QBJV012
3/4"	16	36	38,8	35	3,5	21	QBJV034
1"	16	41,5	44,7	40	3	40	QBJV100
1"1/4	16	53	56,5	44	3	68	QBJV114
1"1/2	16	59	62,6	55	4,5	105	QBJV112
2"	16	74	78,4	62,9	5,5	175	QBJV200

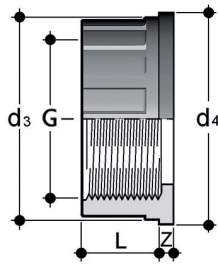

Q/BFV

Union end with BSP female thread for union types BIV, BIFV, BFV, BLV, BIRV, BIFOV, BIROV, BIFXV, BIRXV

R	PN	d ₃	d ₄	L	Z	g	Code
3/8"	16	22	24	11,4	4,5	4,5	QBFV038
1/2"	16	27,5	30,1	15	5	8,5	QBFV012
3/4"	16	36	38,8	16,3	5	15,5	QBFV034
1"	16	41,5	44,7	19,1	5,5	21,0	QBFV100
1"1/4	16	53	56,5	21,4	5,5	33,5	QBFV114
1"1/2	16	59	62,6	21,4	5,5	40,0	QBFV112
2"	16	74	78,4	25,7	5,5	72,0	QBFV200

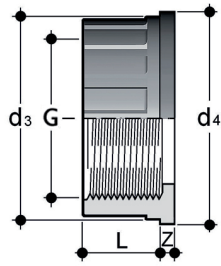

Q/BNV

Union end with NPT female thread for union types BIV, BIFV, BFV, BLV, BIRV, BIFOV, BIOV, BIFXV, BIRXV

G	PN	d_3	d_4	L	Z	g	Code
3/8"	16	22	24	12,7	6,3	10	QBNV038
1/2"	16	27,5	30,1	17,8	5,2	15	QBNV012
3/4"	16	36	38,8	18	5,2	20	QBNV034
1"	16	41,5	44,7	22,6	5,7	30	QBNV100
1 1/4"	16	53	56,5	25,1	7,3	55	QBNV114
1 1/2"	16	59	62,6	24,7	7	70	QBNV112
2"	16	74	78,4	29,6	7,8	115	QBNV200

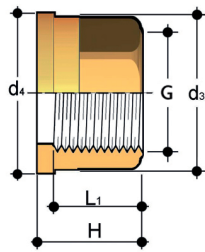

Q/BFO

Union end in brass with female BSP thread for union types BIV, BIFV, BFV, BLV, BIRV, BIFOV, BIOV, BIFXV, BIRXV

G	d_3	d_4	H	L_1	g	Code
3/8"	22	24	21,5	13,5	38	QBFO038
1/2"	27,5	30,1	22,5	16,5	60	QBFO012
3/4"	36	38,8	25,5	18,5	116	QBFO034
1"	41,5	44,7	27,5	19,5	144	QBFO100
1 1/4"	53	56,5	30,5	21,5	260	QBFO114
1 1/2"	59	62,6	33,5	23	325	QBFO112
2"	74	78,4	38,5	27	578	QBFO200

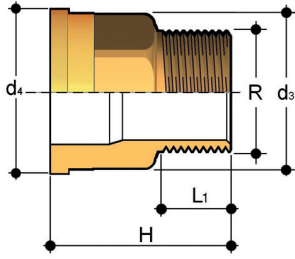

Q/BRO

Union end in brass with male BSP thread for union types BIV, BIFV, BFV, BLV, BIRV, BIFOV, BIROV, BIFXV, BIRXV

R	d ₃	d ₄	H	L ₁	g	Code
3/8"	22	24	34,5	10,5	64	QBRO038
1/2"	27,5	30,1	39	13,5	105	QBRO012
3/4"	36	38,8	43,5	15	184	QBRO034
1"	41,5	44,7	48	17,5	251	QBRO100
1 1/4"	53	56,5	53	19,5	437	QBRO114
1 1/2"	59	62,6	56	19,5	545	QBRO112
2"	74	78,4	65,5	24	937	QBRO200

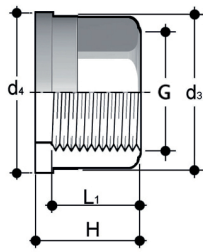

Q/BFX

Union end in A316L stainless steel with female BSP thread for union types BIV, BIFV, BFV, BLV, BIRV, BIFOV, BIROV, BIFXV, BIRXV

G	d ₃	d ₄	H	L ₁	g	Code
3/8"	22	24	21,5	13,5	34	QBFX038
1/2"	27,5	30,1	22,5	16,5	54	QBFX012
3/4"	36	38,8	25,5	18,5	104	QBFX034
1"	41,5	44,7	27,5	19,5	130	QBFX100
1 1/4"	53	56,5	30,5	21,5	234	QBFX114
1 1/2"	59	62,6	33,5	23	293	QBFX112
2"	74	78,4	38,5	27	520	QBFX200

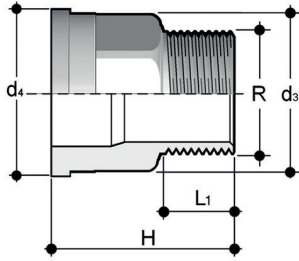

Q/BRX

Union end in A316L stainless steel with male BSP thread for union types BIV, BIFV, BFV, BLV, BIRV, BIFOV, BIROV, BIFXV, BIRXV

R	d ₃	d ₄	H	L ₁	g	Code
3/8"	22	24	34,5	10,5	58	QBRX038
1/2"	27,5	30,1	39	13,5	95	QBRX012
3/4"	36	38,8	43,5	15	166	QBRX034
1"	41,5	44,7	48	17,5	226	QBRX100
1 1/4"	53	56,5	53	19,5	393	QBRX114
1 1/2"	59	62,6	56	19,5	491	QBRX112
2"	74	78,4	65,5	24	843	QBRX200

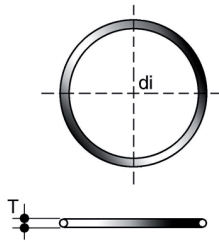

O-RING

O-ring for union types BIV, BIFV, BFV, BLV, BIRV, BIFOV, BIROV, BIFXV, BIRXV

Union D	C	di	T	EPDM code	FKM code
16	3062	15,54	2,62	OR3062E	OR3062F
20	4081	20,22	3,53	OR4081E	OR4081F
25	4112	28,17	3,53	OR4112E	OR4112F
32	4131	32,93	3,53	OR4131E	OR4131F
40	6162	40,65	5,34	OR6162E	OR6162F
50	6187	47	5,34	OR6187E	OR6187F
63	6237	59,69	5,34	OR6237E	OR6237F
75	6300	75,57	5,34	OR6300E	OR6300F
90	6362	91,45	5,34	OR6362E	OR6362F
110	6450	113,67	5,34	OR6450E	OR6450F

all resale products

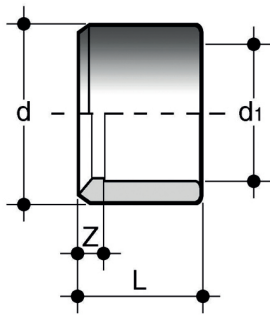

Fig. A

DLV

Reducing bush with solvent weld spigot (d) and solvent weld socket (d1 reduced) (fig. A)

d x d ₁	PN	L	Z	g	Code
1/2" x 3/8"	15	16,5	2	3	DLV012038
3/4" x 1/2"	15	19,5	3	5,5	DLV034012
1" x 1/2"	15	22,5	6,5	18	DLV100012
1" x 3/4"	15	22,5	3	10	DLV100034
1 1/4" x 1"	15	27	4	19	DLV114100
1 1/2" x 1"	15	30	7,5	42	DLV112100
1 1/2" x 1 1/4"	15	31	4	20	DLV112114
2" x 1 1/4"	15	38	12	80	DLV200114
2 1/2" x 2"	15	43,5	7,5	100	DLV212200
3" x 2 1/2"	15	50,5	7	125	DLV300212
4" x 3"	15	63	12	331	DLV400300
5" x 4"	15	76	15	460	DLV500400

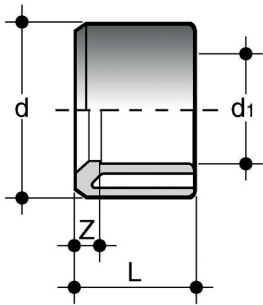
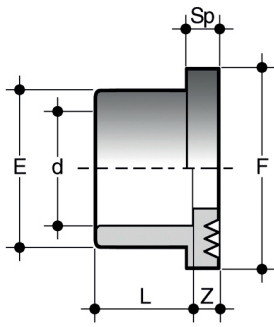

Fig. B

DLV

Reducing bush with solvent weld spigot (d) and solvent weld socket (d1 reduced) (fig. B)

d x d ₁	PN	L	Z	g	Code
1 1/2" x 3/4"	15	30	10	40	DLV112034
2" x 1"	15	36	7	50	DLV200100
2" x 1 1/2"	15	38	7	50	DLV200112
3" x 1 1/2"	15	50,5	20,5	200	DLV300112
3" x 2"	15	51	13	167	DLV300200
4" x 2"	15	63	27	370	DLV400200
6" x 4"	12	90	27	972	DLV600400
8" x 6"	12	115,5	26,5	1400	DLV800600



QLV

Serrated face stub with solvent weld socket, for use with stubs QLV and flat gaskets QHV/X and QHV/Y (QHV/Y only when coupling to ISO/DIN "ODV and ODB" flanges)

d	PN	E	F	L	Sp	Z	g	Class	Code
2"	15	76	90	38	9	4	112	E	QLV200
2 1/2"	15	90	106	44	10	3	165	E	QRV075
3"	15	108	125	51	11	5	273	E	QLV300
4"	15	131	150	61	12	5	439	E	QLV400
6"	12	188	216	86	16	5	1250	D	QLV600
8"	12	250	270	115	20	6,5	2150	D	QLV800

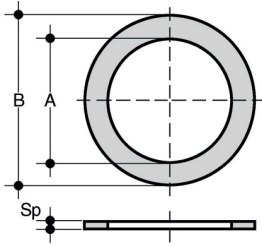

QHV/X

Flat gasket in EPDM and FKM for flanges according to DIN 2501, EN 1092

d	DN	A	B	Sp	EPDM code	FKM code
16	10	16	27	2	QHVX016E	QHVX016F
20 - 1/2"	15	20	32	2	QHVX020E	QHVX020F
25 - 3/4"	20	24	38,5	2	QHVX025E	QHVX025F
32 - 1"	25	32	48	2	QHVX032E	QHVX032F
40 - 1" 1/4	32	40	59	2	QHVX040E	QHVX040F
50 - 1" 1/2	40	50	71	2	QHVX050E	QHVX050F
63 - 2"	50	63	88	2	QHVX063E	QHVX063F
75 - 2" 1/2	65	75	104	2	QHVX075E	QHVX075F
90 - 3"	80	90	123	2	QHVX090E	QHVX090F
110 - 4"	100	110	148	3	QHVX110E	QHVX110F
125	125	125	166	3	QHVX125E	QHVX125F
140	125	140	186	3	QHVX140E	QHVX140F
160 - 6"	150	160	211	3	QHVX160E	QHVX160F
200	200	200	252	4	QHVX200E	-
225 - 8"	200	225	270	4	QHVX225E	-
250	250	250	305	4	QHVX250E	-

all resale products

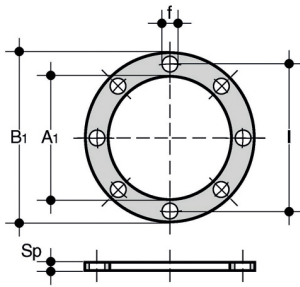

QHV/Y

Flat gasket in EPDM for flanges according to DIN 2501, EN 1092, self-centring for flanges drilled PN 10/16 up to DN 150 and PN 10 from DN 200

d	DN	A ₁	B ₁	F	I	U	Sp	Code
20 - 1/2"	15	17	95	14	65	4	2	QHVY020E
25 - 3/4"	20	22	107	14	76,3	4	2	QHVY025E
32 - 1"	25	28	117	14	86,5	4	2	QHVY032E
40 - 1" 1/4	32	36	142,5	18	101	4	2	QHVY040E
50 - 1" 1/2	40	45	153,3	18	111	4	2	QHVY050E
63 - 2"	50	57	168	18	125,5	4	2	QHVY063E
75 - 2" 1/2	65	71	187,5	18	145,5	4	3	QHVY075E
90 - 3"	80	84	203	18	160	8	3	QHVY090E
110 - 4"	100	102	223	18	181	8	3	QHVY110E
125	125	132	250	18	210	8	3	QHVY125EDN125
140	125	132	250	18	210	8	3	QHVY140E
160 - 6"	150	152	288,5	22	241,5	8	4	QHVY160E
200	200	192	340	22	295	8	4	QHVY200E
225 - 8"	200	215	340	22	295	8	4	QHVY225E
250	250	238	395	22	350	12	4	QHVY250E
280	250	265	395	22	350	12	4	QHVY280E
315	300	290	462	22	400	12	4	QHVY315E
355	350	337	500	22	460	16	2	QHVY355E
400	400	384	555	22	515	16	2	QHVY400E

all resale products

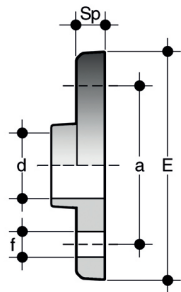

FLV

Flange to BS 10, table E, with solvent weld socket (for gasket sizes, see QHV/X)

d	PN	a	E	f	L	Sp	U	Z	g	Class	Code
1/2"	15	67	95	14	16,5	11	4	5	100	E	FLV012
3/4"	15	73	105	14	19,5	12	4	5	140	E	FLV034
1"	15	82,5	115	14	22,5	14	4	5	200	E	FLV100
1 1/4"	15	87,5	125	14	27	15	4	5	265	E	FLV114
1 1/2"	15	98,5	140	14	31	16	4	5	350	E	FLV112
2"	15	115	165	18	38	18	4	5	500	E	FLV200
3"	15	146	200	18	51	20,5	4	5,5	860	E	FLV300
4"	15	178	220	18	63	22,5	8	5,5	1100	E	FLV400

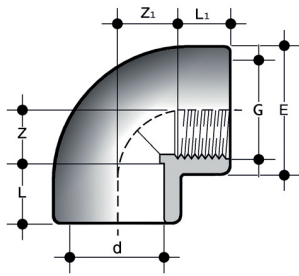

GLFV

90° elbow with solvent weld socket and BSP threaded female end G

d x G	PN	E	L	L ₁	Z	Z ₁	g	Class	Code
1/2" x 1/2"	15	27	16,5	15	10,5	12	13	E	GLFV012
3/4" x 3/4"	15	33	19,5	16,3	13,5	16,7	25	E	GLFV034
1" x 1"	15	41	22,5	19,1	17	20,4	55	E	GLFV100
1 1/2" x 1 1/2"	15	61	31	21,4	27	36,6	170	E	GLFV112
2" x 2"	15	76	38	25,7	33,5	45,8	340	E	GLFV200
2 1/2" x 2 1/2"	12	90	44	30,2	40,5	54,3	420	E	GIFV075212
3" x 3"	12	108	51	33,3	48	65,7	750	D	GLFV300
4 x 4"	12	131	63	39,3	58	81,7	1050	D	GLFV400

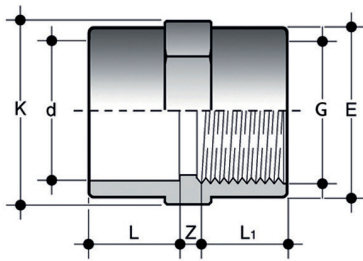

MLFV

Double socket with solvent weld socket d and BSP threaded female end G

d x G	PN	E	K	L	L ₁	Z	g	Class	Code
1/2" x 1/2"	15	27	24	16	15	4	15	E	MLFV012
3/4" x 3/4"	15	33	29	19,5	16,3	5,2	25	E	MLFV034
1" x 1"	15	41	35	22,5	19,1	4,5	45	E	MLFV100
1 1/4" x 1 1/4"	15	50	43	27	21,4	4	65	E	MLFV114
1 1/2" x 1 1/2"	15	61	50	30	21,4	8	100	E	MLFV112
2" x 2"	15	76	61	36	25,7	9	160	E	MLFV200
2 1/2" x 2 1/2"	12	90	76	44	30,2	17,8	260	E	DIFV090075212
3" x 3"	12	108	108	51	33,3	22,7	449	D	MLFV300

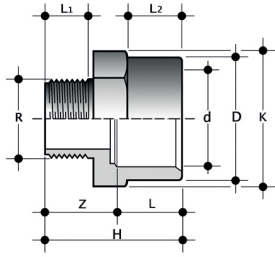

ILFV

Female/male adaptor with solvent weld socket d and BSP threaded male end G

d x G	PN	H	K	L	L ₁	Z	g	Class	Code
1/2" x 1/2"	15	37,5	30	16,5	15	21	20	E	ILFV012
3/4" x 3/4"	15	42	36	19,5	16,3	22,5	22	E	ILFV034
1" x 1"	15	47,5	46	22,5	19,1	25	25	E	ILFV100
1 1/4" x 1 1/4"	15	56,5	55	27	21,4	29,5	65	E	ILFV114
1 1/2" x 1 1/2"	15	62	65	31	21,4	31	98	E	ILFV112
2" x 2"	15	73	80	38	25,7	35	160	E	ILFV200